

 **KENWOOD**

DIGITAL DISPLAY
Model DG-5



OPERATING MANUAL

CONTENTS

FEATURES	3
SECTION 1. CHECKING AND CAUTIONS BEFORE USE	3
SECTION 2. CONTROLS AND WHAT THEY DO	4
SECTION 3. OPERATING INSTRUCTIONS	6
SECTION 4. TROUBLESHOOTING GUIDE	10
SECTION 5. REFERENCE OSCILLATOR FREQUENCY CALIBRATION	11
SECTION 6. CIRCUIT DESCRIPTION	12

Property of
Ban E CIA
W3MKY

FEATURES

- 1. Full, Precise Direct Reading of TS-520S Operating Frequencies As Precise As Order of 100Hz**

Your DG-5 synthesizes all local oscillator output frequencies, including the heterodyne, VFO, and carrier frequencies, displays true TS-520S operating frequencies as precise as an order of 100Hz. It needs no frequency correction and calibration even when the band and mode of operation are switched.
- 2. Countable up to 40MHz With Single Switching**

Single Switching on the front panel permits your DG-5 to count frequencies up to 40MHz in units of 100Hz. Thus, it is useful as a frequency counter for your shack.
- 3. Neat Thin Shape Matching Well With TS-520S**

Your DG-5 is elaborated thinly in the height to match well with the TS-520S as put on its top. Thus, it provides comfortable operation.
- 4. Light-Emitting Diode Frequency Display With Dimmer Switch**

Large, light-emitting diodes (LEDs) are easy to read as your DG-5 is the independent frequency display and counter. The LEDs can be halved in the light intensity by turning the DIM (dimmer) switch to ON. Also, the LEDs, which are color-masked, make you free from fatigue for an extended period of operation, particularly at night.
- 5. Simple Connection With TS-520S**

Your DG-5 can be easily interconnected with the TS-520S by plugging the heterodyne, VFO, and carrier cables and the power cord only. These signal cables are individual to minimize spurious and other undesirable signal levels.
- 6. Available for Use With TS-520**

Notice that your DG-5 is tailored specifically for the new TS-520S. But, if you have the previous TS-520, you can add a DK-520 Adapter to it for enabling the DG-5 to be applied to it.

SECTION 1. CHECKING AND CAUTIONS BEFORE USE

This manual was prepared to chiefly describe how to use your DG-5 Digital Display connection with the KENWOOD's Model TS-520S SSB Transceiver.

1-1 ACCESSORIES

Carefully unpack your DG-5 and check that it is supplied with the following accessories.

1. Operating manual 1 copy.
2. Warranty card 1 copy.
(U.S.A. only).
3. Pin plug-equipped signal cables (red, white, black, gray) 1 piece each.
4. Counter cable 1 piece.
5. Power cord 1 piece.
6. Auxiliary foot 2 pieces.
7. Screw, auxiliary foot 2 pieces.

1-2 PRECAUTION FOR CONNECTION WITH TS-520S

Your DG-5 is designed for specific use with the TS-520S. Before connection, fully understand the operation of the TS-520S by reading its operating manual.

1-3 PRECAUTION FOR CONNECTION WITH TS-520

Your DG-5 cannot be combined with the TS-520 unless the DK-520 Adapter is used to provide the TS-520 with connection terminals.

SECTION 2. CONTROLS AND WHAT THEY DO

2-1 FRONT PANEL (see Figure 1)

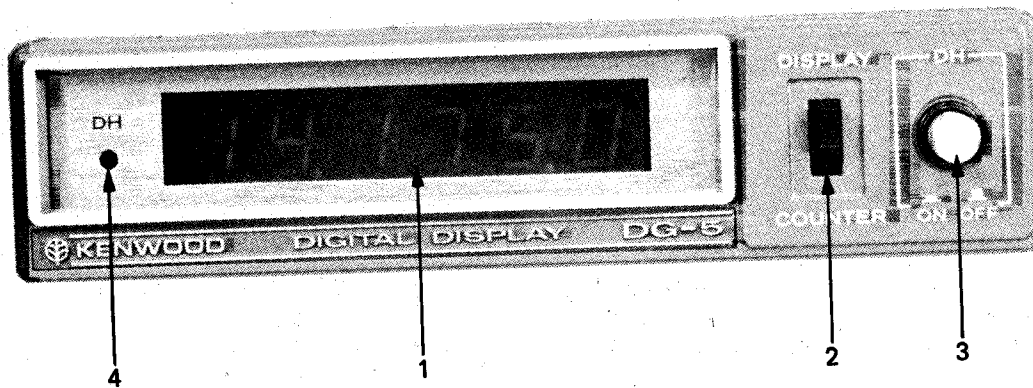

Figure 1. Front Panel Controls

1. Digital Frequency Display

Six digit 7-segment light-emitting diodes (LEDs) illuminate input frequencies in digital way. The leftmost two digits are in units of MHz, the succeeding three digits of kHz, and the rightmost digit of 100Hz. These are sectioned by two points. If the VFO or heterodyne local oscillator signal is disconnected with the DISPLAY-COUNTER selector in the DISPLAY position, the LEDs but the points go off ("blinking"). This shows a defect of the signal connection cable(s).

2. DISPLAY-COUNTER Selector

DISPLAY position: The DG-5 displays the TS-520S operating frequencies.

COUNTER position: The DG-5 operates as frequency counter, having DC power supplied from the TS-520S. To input a given signal, connect to the COUNT. IN connector on the rear panel.

3. DH (Display Hold) Switch

Used to hold the input channel frequency displayed as the time right before pressed in "ON". The frequency display will not change irrespective of the operation mode and frequency changes of the TS-520S. This is convenient to see other channels and to return to the original channel as the DG-5 serves as a frequency memory.

4. DH Indicator

The DH indicator lights and shows the "DH" state when the DH switch is in ON.

2-2 REAR PANEL (see Figure 2)

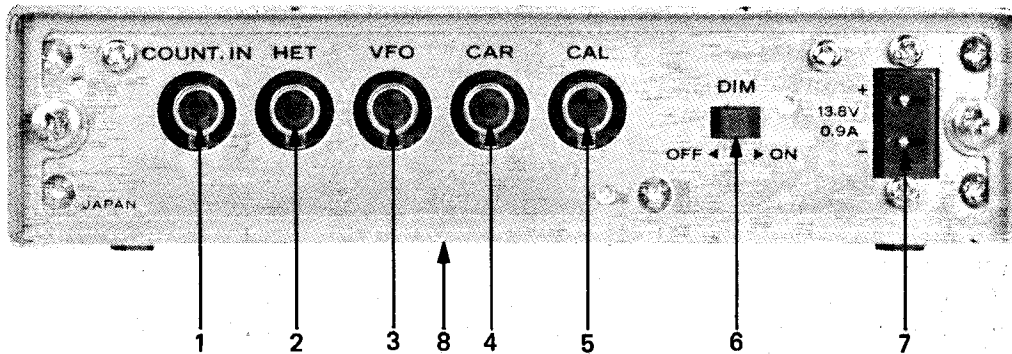

Figure 2. Rear Panel Controls

1. COUNT IN Connector

A counter input connector. Use the supplied counter cable equipped with insulated alligator clips. While the DG-5 is used as the frequency display, disconnect the cable to avoid entering the transmit wave which could cause wrong frequency indication.

2. HET Connector

The HET connector is used to input the heterodyne local signal of the TS-520S. To connect to it, use the supplied signal cable.

3. VFO Connector

The VFO connector is used to input the VFO signal of the TS-520S. To connect to it, use the supplied signal cable.

4. CAR Connector

The CAR connector is used to input the carrier signal of the TS-520S. To connect to it, use the supplied signal cable.

5. CAL Connector

This connector outputs the internal reference oscillator signal to calibrate its frequency by producing zero beat with the WWV or similar standard radio frequencies. Connected to the TS-520S X VERTER IN connector with the supplied signal cable. Keep the cable disconnected when not in calibration.

6. DIM (Dimmer) Switch

The DIM switch halves the display bright glaring in a dark place or at night when set to the ON position.

7. 13.8V, 0.9A DC Power Connector

This connector supplies the TS-520S 13.8V, 0.9A DC power into the DG-5. For connection, use the supplied power cord. It may connect other power supplies of the same rating, for example, the KENWOOD Models PS-6 and PS-8.

8. Reference Oscillator Frequency Calibration Hole

The trimmer inside the hole is used to calibrate the reference oscillator frequency.

SECTION 3. OPERATING INSTRUCTIONS

3-1 CONNECTION WITH TS-520S (see Figure 3)

Interconnection of your DG-5 with the mother equipment, or your TS-520S can be completed by plugging the signal cables and power cord only as shown in Figure 3. Notice that the DG-5 and TS-520S are different in the order of the connectors. Be careful of inserting the pin plug of each coaxial signal of the same color into the connectors of the same reference. The DG-5 orders the HET, VFO, and CAR connectors, and the TS-520S the VFO, HET, and CAR connectors as viewed toward the rear panels. Correct connection allows the DG-5 to work immediately when the TS-520S POWER switch is turned on.

The DG-5 is designed to well match with the TS-520S when placed on it.

3-2 OPERATION FOR FREQUENCY DISPLAY

The DG-5 operates with the HET, VFO, and CAR signals as well as the DC power supplied from the TS-520S. The DG-5, therefore, displays the operating frequency as controlling the TS-520S. The following describes how to use the TS-520S controls in connection with appropriate operations and checking of the DG-5.

1. Set-up

DG-5: Set the DISPLAY-COUNTER selector to DISPLAY.

Set the DH switch to OFF.

TS-520S: Set in the receive mode of operation. Set the SG switch on the rear panel to OFF to avoid transmitting any undesirable wave during checking.

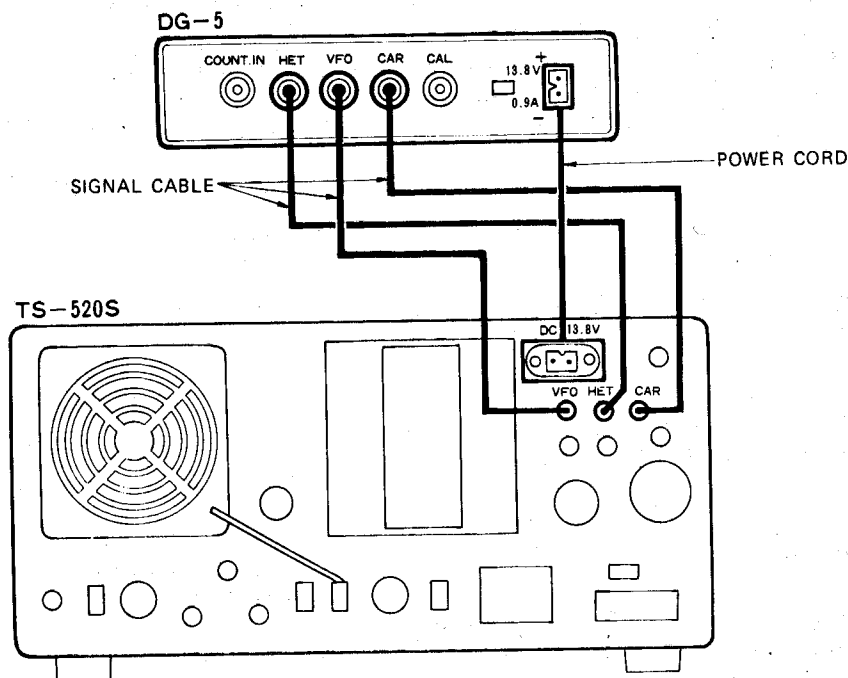

Figure 3. Interconnection of DG-5 with TS-520S

2. BAND switch and Main Tuning Knob

Turn the TS-520S BAND *switch from WWV to 29.1 step by step, and the DG-5 will display each band frequency in units of MHz. Turning the Main Tuning knob will change the display frequency. When the BAND switch is at AUX, all digits except the points will go off unless the AUX circuit is built in the TS-520S. This results from the action of the DG-5 blanking circuit with it having neither HET nor VFO signal input.

3. MODE switch

Turning the MODE switch will change the carrier frequency, that is, this changes with the modes of operation: USB, LSB, CW transmit or receive. For example, assume that the switch is set to TUN and the display frequency to "14.100.0". Turning the switch will change the display frequency as shown below.

TUN	CW	USB	LSB
14.100.0	REC: 14.100.8* SEND: 14.100.0	14.098.5*	14.101.5*

NOTE (*): These values may deviate slightly with a differnt setting of the carrier point.

4. FUNCTION switch

When operating the TS-520S alone or in a fixed channel, turning the FUNCTION switch will change the display frequency as shown below.

FUNCTION SW POSITIONED AT:		RECEIVE	SEND
C A L	FIX	Heterodyne freq - 10 MHz	
	RMT		
	25kHz		
VFO		MAIN*	
VFO-R		MAIN*	BLK* or FIX*
FIX-R		BLK* or FIX*	MAIN*
FIX		BLK* or FIX*	

NOTE (*): "MAIN" indicates the TS-520S Main Tuning knob set frequency.
 "BLK" is the blanking state where no digits appear.
 "FIX" is the fixed channel frequency.

If using a remote VFO, for example, the KENWOOD's Model VFO-520S, notice that the display frequency will change as the remote

VFO FUNCTION switch turns. For details, reference should be made to its operating manual.

5. RIT control and switch

The RIT control changes the receiver tuning frequency alone when the RIT switch is pressed in "ON". While the RIT circuit is in operation, the display frequency will change by switching the mode of operation from transmit to receive, and vice versa.

3-3 OPERATION FOR FREQUENCY COUNTING

Your DG-5 is made a frequency counter measurable frequencies as wide as 100Hz to 40MHz by setting the DISPLAY-COUNTER selector to COUNTER. To input an unknown frequency, connect to the COUNT. IN connector on the rear panel with the supplied counter cable.

If the given circuit is low in the impedance, or below several kilohms for the DG-5, the cable may be directly connected to the circuit. In general, frequency counters contain at the cable end around 100pF capacitance and some input resistance; the DG-5 has 22pF plus 60 to 65pF cable capacitance and 5kΩ resistance. At frequencies as high as order of MHz or as low as audio frequencies, a high-impedance circuit could fail to work or deviate the output frequency when the cable is connected to the circuit. In such a case, connect a proper coupling resistor, capacitor, or attenuator to the cable end as shown in Figure 4. This is to prevent the

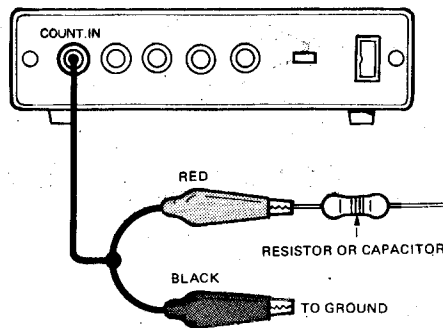

Figure 4. Resistor or Capacitor Placed for Accurate Frequency Counting.

capacitance and others of the cable from affecting the circuit under measurement. A series resistor is effective in measuring high-impedance circuits and a series capacitor is adequate for high frequency circuits. The higher the signal level of the circuit under measurement, the higher the resistor or the smaller the capacitor can be placed. Therefore, it is recommended that the resistor be as high and the capacitor as small as the DG-5 can measure. This is useful to minimize affecting of the DG-5 to the circuit under measurement.

As your DG-5 has a very high sensitivity, it could pick up the transmit wave or the waves leaking from connection cables, particularly in measuring low frequencies. This could result in irregular frequency counting. To prevent such an adverse effect, also, the series resistor or attenuator is adequate.

The COUNT. IN connector withstand voltage is 200V DC at the peak value or 5V AC at the root-mean-square value. For measuring the frequencies at most electron tube circuits and at the outputs of transmitter final stages, be careful not to directly connect the counter cable to any of the high voltage points and antenna connector.

Should an input exceeding the withstand voltage come into the connector, the counter input resistor could be burnt out. To prevent such an accident, place a capacitor as small as 1 to 2pF in series or use a pick-up coil by winding around the antenna coaxial cable or bringing near the circuit which is, for example, a tank coil as illustrated in Figure 5.

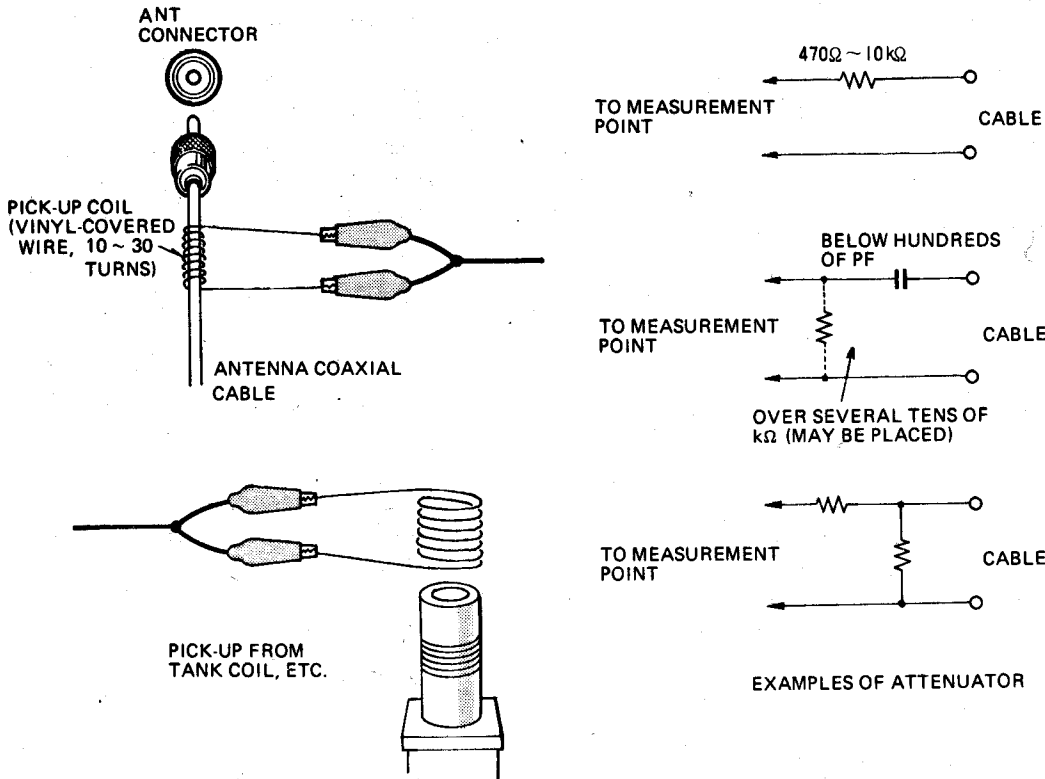

Figure 5. Counter Cable Coupling Methods for High-Tension, Low Impedance, High Frequency Circuits.

3-4 USE OF DH SWITCH

The DH (Display Hold) switch is for use to hold the frequency display right before it is pressed in "ON". In the ON state, the displayed frequency will not change irrespective of the mode and operating frequency of the TS-520S. The TS-520S operating channel can be shifted to another frequency to check at a glance and can be immediately returned to the original channel.

Therefore, the DH feature is available as a sort of memo.

In the DH mode of operation, the shifted

frequency is to be read on the analog Main Tuning knob and Sub-dial of the TS-520S. If used as the frequency counter, your DG-5 also can hold the displayed frequency as long as necessary with the DH switch in the ON position.

3-5 AUXILIARY FOOT INSTALLATION

The auxiliary feet, when installed, will raise the front panel up around 8 mm (3-1/8 inches). To install, refer to Figure 6.

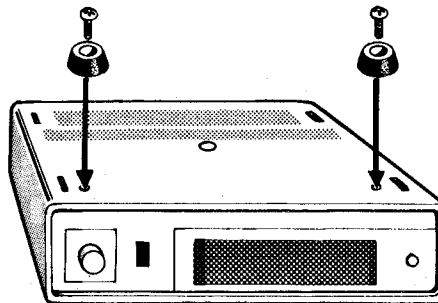

Figure 6. Auxiliary Foot Installation.

SECTION 4. TROUBLESHOOTING GUIDE

The symptoms listed below are in no way indications that your DG-5 is defective. If trouble with the DG-5, it cannot be remedied even after the following checks have been performed, consult your dealer or your nearest service station.

SYMPTOM	PROBABLE CAUSE	REMEDY
<p>1. Display will not light.</p> <p>1.1 Neither points nor DH indicator will light.</p> <p>1.2 Both points and DH indicator light up.</p>	<p>DC power is not supplied to DG-5.</p> <p>Heterodyne and/or VFO signal does not come into DG-5.</p>	<p>Firmly plug power cord into power connector.</p> <p>Make certain that signal cables are connected correctly. Set DISPLAY-COUNTER selector to COUNTER. Connect HET, VFO, and CAR signal cables to COUNT IN connector one by one. Make certain that their frequencies are displayed correctly. For HET and CAR frequencies, refer to "TS-520S Operating Manual". VFO frequency is 5.5 MHz when TS-520S Sub-dial is at "0" and 4.9 MHz at "600".</p>
<p>2. Display is in "0.000.0".</p>	<p>DISPLAY-COUNTER selector is at COUNTER.</p>	<p>Turn selector to DISPLAY.</p>
<p>3. Display will not read correct frequency.</p>	<p>Wrong signal cable connection. No signal comes to CAR connector when display reads HET frequency minus 10MHz.</p>	<p>Check to see whether signal cable connection is correct or not.</p>
<p>4. Turning Main Tuning knob will not vary display frequency.</p>	<p>Wrong signal cable connection. DH switch is in ON.</p>	<p>Check to see whether signal cable connection is correct or not. Set DH switch to OFF.</p>
<p>5. Display flickers when FUNCTION switch is in RMT or CAL-FIX.</p>	<p>Blanking circuit is made to operate by DG-5 input signal modulated with phase shift of internal VFO signal from external VFO or FIX signal when former is calibrated with latter and two signals are at close levels.</p>	<p>Flickering gives no adverse effect for correct frequency display. VFO signal is calibrated when flickering goes off.</p>
<p>6. Display frequency deviates a little (around several hundreds of Hz).</p>	<p>Reference oscillator frequency is not correct.</p>	<p>Calibrate reference oscillator (see page 11).</p>
<p>7. Display frequency fluctuates too much to measure, particularly at low frequencies (below 500kHz).</p>	<p>DG-5 picks up transmit wave or waves leaking from connection cables, particularly HET.</p>	<p>Try to stop transmission or to remove connection cables.</p>

SECTION 5. REFERENCE OSCILLATOR FREQUENCY CALIBRATION

Your DG-5 was completely aligned at the factory. However, the reference oscillator frequency sometimes may deviate with secular change. In such an event, calibrate it as directed below.

CAUTION

Before calibration, wait over one hour for the DG-5 to warm up after power-on.

1. Set the TS-520S BAND switch to WWV to receive the 15MHz standard wave.
2. Connect the supplied signal cable from the DG-5 CAL connector to the TS-520S XVERTER IN connector as shown in Figure 7. The fifteenth harmonic of the DG-5

reference oscillator fundamental, 1 MHz, will superimpose on the 15MHz WWV signal. Then you will hear of an impure, double beat.

3. Adjust the trimmer located inside the bottom cover using an adjust screwdriver until the impure beat becomes clear, as shown in Figure 7. For more precise adjustment, the S meter on the TS-520S is helpful. The S meter pointer will vibrate finely on either side of the true calibration point. As the reference oscillator frequency comes close to the calibration point, the pointer deflection becomes large and slow. When it is largest and slowest, set the trimmer.

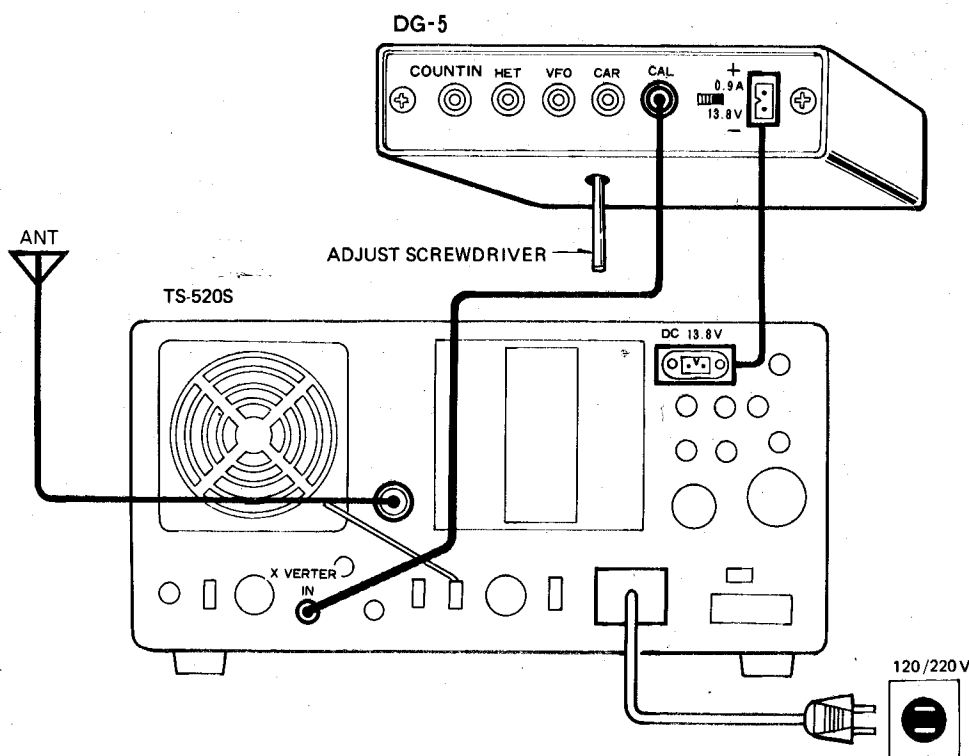

Figure 7. Reference Oscillator Calibration.

SECTION 6. CIRCUIT DESCRIPTION

6-1 BLOCK AND SCHEMATIC DIAGRAMS

A block diagram of your DG-5 is shown in Figure 8 and a schematic diagram in page 15. The whole circuit consists chiefly of a signal amplifier, an analog mixer, a digital counter, and a power supply.

6-2 PRINCIPLES OF OPERATION

The TS-520S operating frequency is made up as: $HET - (VFO + CAR)$.

In the DG-5 where two counter circuits are connected in series, the heterodyne signal is fed to the lower counter. This lower counter subtracts 10MHz from the heterodyne frequency in a digital way ($HET - 10MHz$). The subtracted

frequency presets the upper counter. The other signal fed to the upper counter is composed in the manner that the carrier frequency is mixed with the 10MHz reference frequency and the resultant is further mixed with the VFO frequency $[(10MHz - CAR) - VFO]$. This signal is added to the one preset by the lower counter, that is:

$$\begin{aligned} & [(10MHz - CAR) - VFO] + (HET - 10MHz) \\ & = HET - (VFO + CAR). \end{aligned}$$

As explained above, you will find that the DG-5 should display the correct TS-520S operating frequency. The reason of using such a complicated construction is that if the DG-5 is the same as the TS-520S in the construction, this can produce a signal of the same frequency as the receive frequency. The signal interferes as spurious with the operation of the TS-520S.

BLOCK DIAGRAM

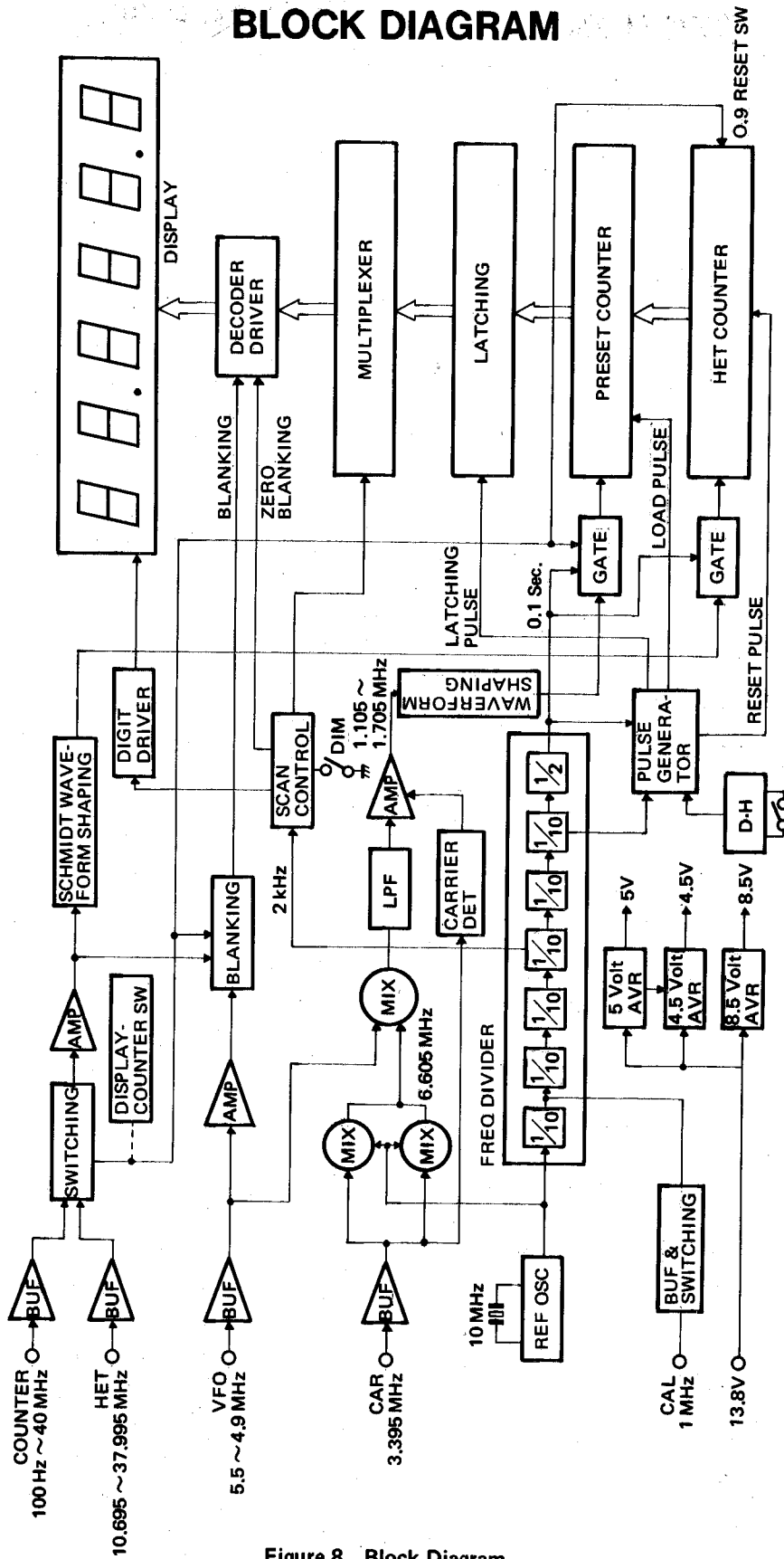
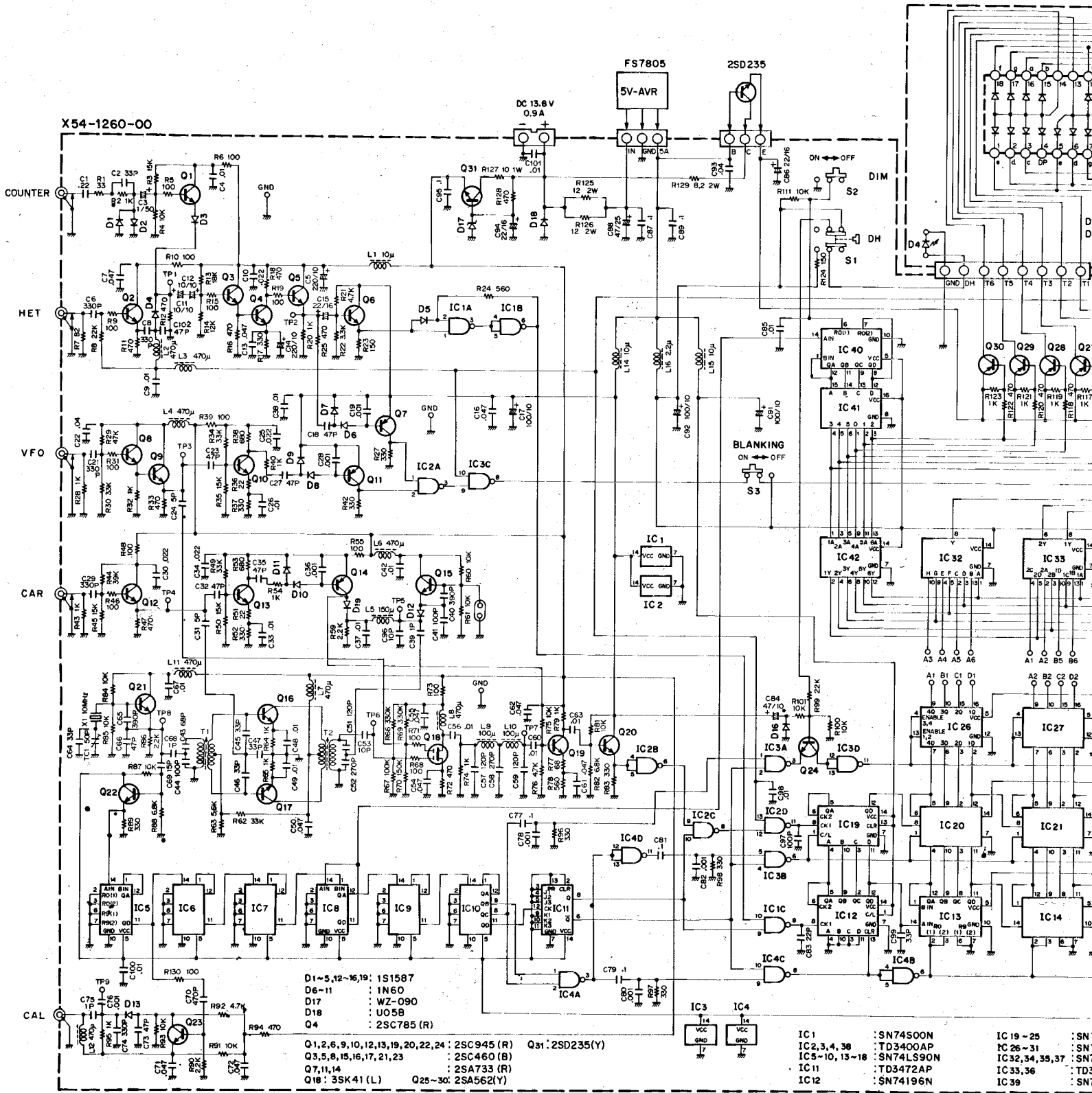
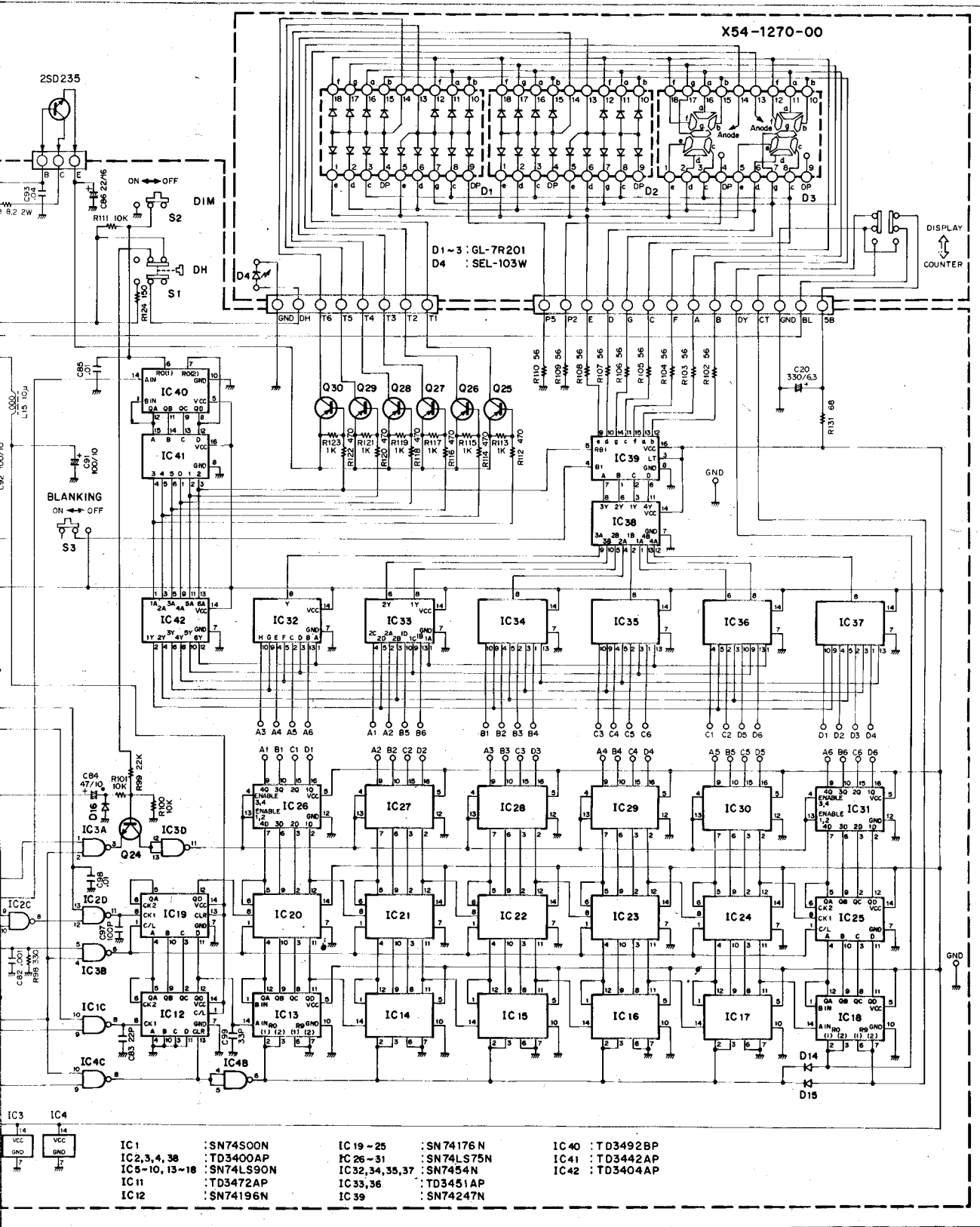

Figure 8. Block Diagram.

SCHEMATIC DIAGRAM



SCHEMATIC DIAGRAM



Schematic Diagram

SPECIFICATIONS

Countable Digits Six decimal digits.
Type Light-emitting diode frequency display with hold memory.

DISPLAY (in combination with TS-520S)

Frequency Range All TS-520S transmit and receive channel frequencies as precise as 0.1kHz digit.
Accuracy Reference time ± 0.2 count.
Input TS-520S heterodyne local oscillator signal, VFO signal, and all carrier oscillator signals.

COUNTER

Measurable Frequency Range 100Hz to 40MHz.
Input sensitivity 50mV r.m.s at 10kHz to 10MHz.
(at Room Temperature) 200mV r.m.s at 100Hz to 40MHz.
Absolute Max Input 200V (DC + peak).
Level 5V r.m.s (continuous at 100Hz to 40MHz).
Input Impedance Approx. $5k\Omega$, less than 22pF.
Accuracy Reference time ± 0.1 count.
Count Time 0.1 sec.
Least Significant Digit 0.1 kHz.

REFERENCE TIME

Frequency 10MHz.
Error Less than 1×10^{-5} (at room temperature).
Temp. Stability Greater than 3×10^{-5} (at 0°C to +50°C).
Aging Rate Lower than 1×10^{-6} /month (at room temperature).

GENERAL

Ambient Temperature -10°C to $+50^{\circ}\text{C}$.
Power Supplied from TS-520S.
External Power 12 to 16V, 0.9ADC (with 13.8V reference).
Dimensions 167mm (6-9/16") wide x 260mm (10-1/64") [268mm (10-1/16"), max.] deep x 40mm (1-37/64") [43mm (1-11/16"), max.] high.
Net Weight 1.27kg (2.8 lbs)
Semiconductors Used 42 ICs, 31 transistors, 19 diodes, 3 two-digit LEDs, and 1 LED indicator.



A product of
TRIO-KENWOOD CORPORATION

6-17, 3-chome Aobadai, Meguro-ku, Tokyo 153, Japan

© 7454 PRINTED IN JAPAN B50-2536-00 (KO)

(K.W)